

Article number: 231111321

Description: E+G Visual flow indicators HVF.92-1/2

Measures

HVF. (66 - 92)
HVF-SST (66 - 92)

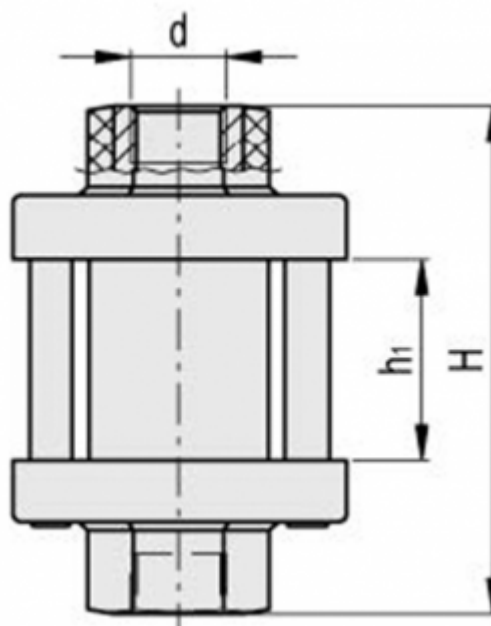
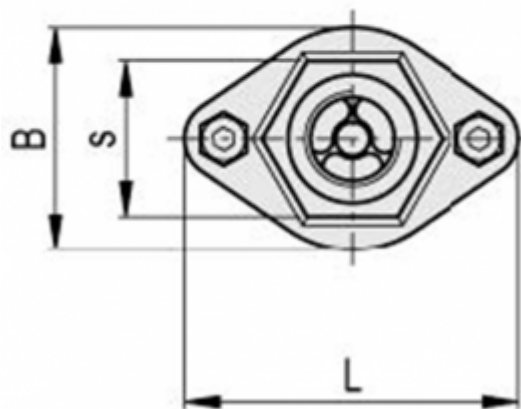

B	= 40
d	= 1/2
H	= 92
h1	= 36
L	= 60
s	= 28
Weight in (g)	= 167